

# ECOLUXX I B

## Recessed light fittings

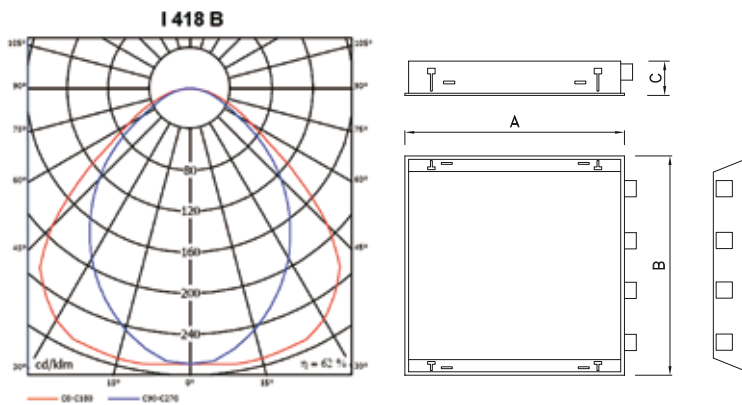

I418B



**Body:**

White painted (RAL 9003) metal sheet

**Optic:**

B white parabolic louvre

**Wiring:**

- compensated, ballast cat. B
- EP high frequency ballast
- EPSA HFB analogue dimmable 1–10 V
- EPSD HFB digital dimmable

**Application:**



























Recessed light fitting for installation into false ceiling with visible supporting structure (600x600 / 625x625 modules) or gypsum plasterboard type ceiling.

**Accessories:**

- Fixing clips for installation into gypsum plasterboard – 54214
- Reduction frame for installing the 600 module light fitting into the 625 module frame

**Versions:**

- 600 for 600 module
- 625 for 625 module
- K with WIELAND connector
- F with flexible cord
- NZ emergency pack
- OK 2 circuit wiring

	#	W	Modul 600			Modul 625			C	kg
			A	B		A	B			
I118B#	600, 625, EP, K, F, NZ	1x18	596	184	 576x164	622	184	 602x164	94	2,1
I218B#	600, 625, EP, K, F, NZ	2x18	596	296	 576x276	622	310	 602x290	94	2,5
I318B#	600, 625, EP, K, F, NZ, OK	3x18	596	596	 576x576	622	622	 602x602	94	4,8
I418B#	600, 625, EP, K, F, NZ, OK	4x18	596	596	 576x576	622	622	 602x602	94	4,9
I136B#	600, 625, EP, K, F, NZ	1x36	1196	184	 1176x164	1246	184	 1226x164	94	2,9
I236B#	600, 625, EP, K, F, NZ, OK	2x36	1196	296	 1176x276	1246	310	 1226x290	94	4,9
I336B#	600, 625, EP, K, F, NZ, OK	3x36	1196	596	 1176x576	1246	622	 1226x602	94	9,1
I436B#	600, 625, EP, K, F, NZ, OK	4x36	1196	596	 1176x576	1246	622	 1226x602	94	9,5
I158B#	600, 625, EP, K, F, NZ	1x58	1496	184	 1476x164	1546	184	 1526x164	94	3,9
I258B#	600, 625, EP, K, F, NZ, OK	2x58	1496	296	 1476x276	1546	310	 1526x290	94	6,1
I358B#	600, 625, EP, K, F, NZ, OK	3x58	1496	596	 1476x576	1546	622	 1526x602	94	10,5
I458B#	600, 625, EP, K, F, NZ, OK	4x58	1496	596	 1476x576	1546	622	 1526x602	94	12,0

# - add to the basic code

 - cut out